

**INSTRUCTION MANUAL
UV LAMP 4
UV CABINET 4**

Contents

- 1 Introduction..... 2**
 - 1.1 *Intended Use*..... 2
 - 1.2 *Precaution*..... 2
 - 1.3 *Parts supplied*..... 4
 - 1.4 *Spare Parts*..... 4

- 2 Unpacking/Installation 5**
 - 2.1 *UV Lamp 4*..... 5
 - 2.2 *UV Cabinet for UV Lamp 4*..... 5

- 3 Getting started 7**
 - 3.1 *Normal Operation* 7
 - 3.2 *Safety Mode* 7
 - 3.3 *Error Mode* 7

- 4 Service and maintenance 8**
 - 4.1 *Replacing fluorescent tubes* 8
 - 4.2 *Cleaning* 8

- 5 Technical data..... 10**
 - 5.1 *UV Lamp 4*..... 10
 - 5.2 *UV Radiation*..... 10
 - 5.3 *UV Cabinet for UV Lamp 4*..... 11

EC Declaration of Conformity

1 Introduction

1.1 Intended Use

The CAMAG UV Lamp 4 is designed for use in the TLC laboratory. It is also suitable for many other applications such as checking authenticity of documents, banknotes etc., to identify invisibly labelled objects in forensic, for mineralogical investigations and much more.

- Long wave UV light 366 nm
Under this kind of UV light, substances with either inherent or reagent induced fluorescence appear as bright spots, often differently colored, on a dark background. The sensitivity of such a detection method increases with the intensity of long wave UV light and with the elimination of visible light. A fluorescent indicator F254 contained in the layer of a TLC plate neither contributes to, nor interferes with, this detection method.
- Short wave UV light 254 nm
This kind of UV light renders substances visible which absorb at 254 nm if the TLC layer contains a fluorescent indicator F254. These substances appear as dark spots on a bright background. For this detection method, UV intensity and complete elimination of visible light are less critical.

CAMAG wavelength statement:

In literature, both UV 365 nm and UV 366 nm are used to describe the UV light spectra used for TLC/HPTLC. CAMAG decided to use UV 366 nm – thus, this (CAMAG's UV 366 nm spectra) is identical to the light spectra described as UV 365 nm.

1.2 Precaution

- Please read this operating manual before starting the installation! This manual contains information, warnings and instructions the user has to follow to ensure reliable operation of the instrument
- If the instrument is used in a manner not specified in this manual, the safety of the user cannot be guaranteed
- Some interior parts of the instrument are under AC power. Careless and improper use can cause injury. Unauthorized manipulations can cause damage
- This sign indicates (on the instrument and in this manual) that failure to take note of the accompanying information may result in damage of the instrument
- The instrument is manufactured and tested in accordance with the respective European safety publications shown on the Declaration of Conformity (DoC). The instrument complies with safety class 2 and has been designed for indoor use only



(IP 20). Furthermore, this device has passed the CAMAG Quality Assurance tests and has been delivered in safe operation condition. For detailed instrument data, see the chapter "Technical Data"

- Attention: For safety reasons the instrument may only be used for the purposes described in the operating manual
- To avoid injury use adequate safety equipment (protective goggles, gloves etc. if applicable) when working with the instrument
- Before first operation, check whether the voltage shown on the instrument matches your local mains voltage. The power cord may only be connected to a grounded, fused (not higher than 16A) outlet. Do not use extension cords without ground contact
- When working with the fluids of the instrument, be sure to take appropriate precautions (protect your eyes from direct contact with liquid)
- The instrument may be used only by properly trained laboratory staff
- The instrument may not be used in rooms with an explosion risk
- The instrument contains highly sophisticated electronics. It may be operated only in a non-condensing atmosphere in the temperature range outlined in the chapter "Technical Data". Before installation and use, the instrument should be acclimated properly
- Use a damp lint-free cloth for cleaning the instrument surface. Do not employ aggressive detergents
- Protect yourself and the instrument from electrostatic shock which can cause damage to the electronic parts
- Only authorized personnel may open the instrument. Service and repair are only to be performed by trained specialists. Use spare parts and consumables supplied by CAMAG only. The warranty is voided if parts from other sources are used. Check the service manual before you start service to reduce product-specific risks
- The power cord has to be removed before the instrument is opened. It is not permitted to work on an instrument that has been opened and is connected to the power supply
- Use only the original power cord type that was delivered with the instrument
- If the instrument is found to be defective, it must be switched off and steps must be taken to ensure that it cannot be switched on by mistake
- Carry out all safety checks and preventive maintenance as recommended by the manufacturer in order to assure your personal safety and the full functionality of the instrument. Have an authorized service specialist perform any service not described by this manual

- See original manufacturers' manuals for further safety data on third party equipment supplied with the system
- Lift/move/transport the system with the necessary care and with sufficient manpower (install the transport security devices if applicable, transport it only in the original packaging)
- This symbol indicates that this equipment must not be disposed of as unsorted municipal waste but is to be collected separately as electrical and electronic equipment (WEEE-Directive 2002/96/EC). To properly recycle the instrument or its parts, you are requested to send the equipment back to the distributor, producer or an adequate collection system at the end of its life. This will have potential effects on the environment and human health



1.3 Parts supplied

UV Lamp

Part no	Description
022.9160	UV Lamp 4 (1 x UV 254 nm & 1 x UV 366 nm, each 8 W)
372.0035	Switching Power Supply
	AC Power Cord
B.022.9160E	Instruction Manual

Table 1

UV Cabinet 4

Part no	Description
022.9060	Viewing Box 4

Table 2

1.4 Spare Parts

Part no	Description
352.0010	UV tube short-wave (254 nm) 8W, d = 16 mm, l = 288 mm
352.0011	UV tube long-wave (366 nm) 8W, d = 16 mm, l = 288 mm
692.0050	UV filter for UV Lamp

Table 3

2 Unpacking/Installation

2.1 UV Lamp 4

The UV lamp should only be operated in combination with the UV Cabinet 4.



Attention

High UV intensities can be harmful. Do not operate the UV Lamp without precautions. Avoid direct and indirect radiation especially to skin and eyes.

- ✓ Connect the UV lamp to a suitable power outlet with the supplied switching power supply.
- ✓ The lamp is switched on/off with the corresponding (254/366) button.
- ✓ After 10 minutes, the timer automatically switches off the lamp
- ✓ The 10 minutes timer can be disabled by pressing the respective button for more than 3 seconds.
(Button LED is blinking)

2.2 UV Cabinet for UV Lamp 4

The UV Cabinet is used for inspecting TLC plates under UV light in a bright environment. A glass filter protects the eyes against UV light reflected during inspection through the viewing window.



Attention

- *Your eyes are protected against reflected UV light by a glass filter in this setup. Make sure to wear a face mask or protective goggles if you are not looking through the viewing window with the UV lamp switched on.*
 - *Be aware of UV radiation: Never work with unprotected skin areas under UV light, e.g. when marking plates!*
-
- ✓ Place the UV Cabinet 4 on a suitable surface such as a laboratory bench with the opening (shutter) towards the user.
 - ✓ Remove the shipping protections at both sides of the UV filter (see Figure 1).

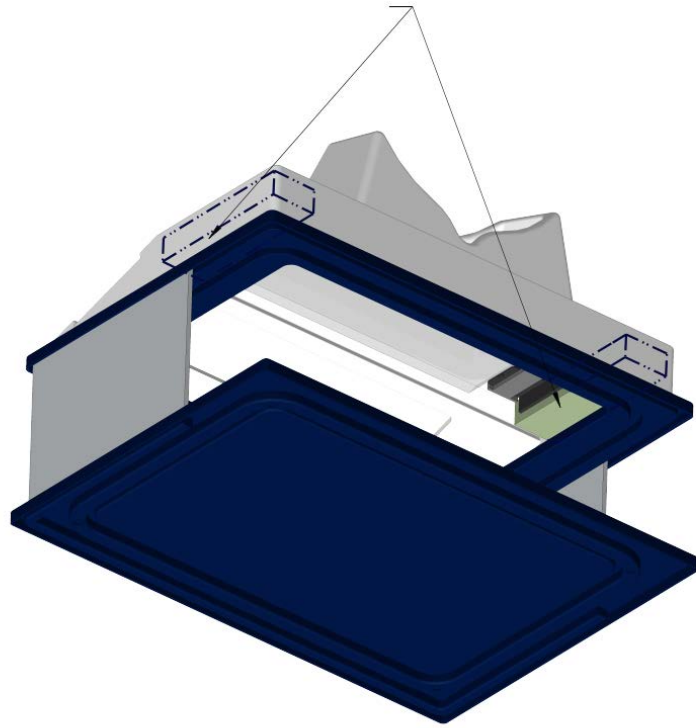

Figure 1

- ✓ Place the UV lamp in the recess provided on top of the UV Cabinet 4.

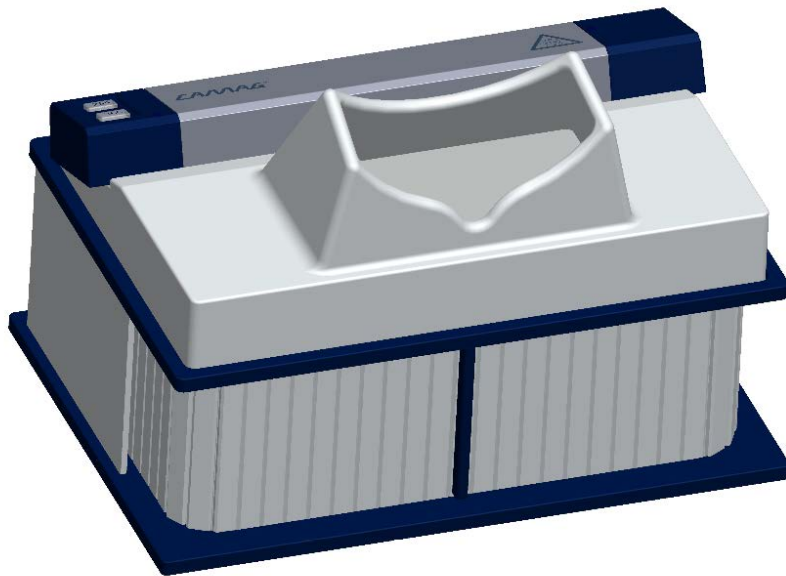

Figure 2

3 Getting started

3.1 Normal Operation

The lamp is switched on/off with the corresponding (254/366) button.

The 10 min timer can be disabled by pressing the button for more than 3 seconds (button LED is blinking).

Lamp	Button
UV C (254 nm) / Timer active	press button 254 ($t \leq 3$ sec)
UV C (254 nm) / Timer off	press button 254 ($t > 3$ sec)
UV A (366 nm) / Timer active	press button 366 ($t \leq 3$ sec)
UV A (366 nm) / Timer off	press button 366 ($t > 3$ sec)

Table 4

3.2 Safety Mode

The Lamp has a built in safety mode which is active when either the lamp is tilted more than 30° or when the lamp temperature reaches a certain limit.

It is indicated by the blinking of the green or blue LED, depending on the active tube.

The Safety Mode is deactivated as soon as the normal operating conditions are met again.

3.3 Error Mode

The Lamp has a built-in error mode, which is active when an over-current or an over-temperature is detected. This is indicated by alternating blinking of the green and blue LED.

The Error Mode is deactivated by simultaneously pressing the 254 nm and 366 nm button or a power on reset.

4 Service and maintenance

Attention



- Before opening the lamp, detach the power cord from the lamp.

4.1 Replacing fluorescent tubes

Over time the UV tube intensity decreases. It is therefore advisable to replace the tube approximately every two years if the lamp is frequently used.

- ✓ Before replacing tubes, detach the power cable from the lamp.
- ✓ Unscrew the screws in the filter holding plate.
- ✓ The old tube can now be taken out of the socket by turning it approx. 90°.
- ✓ Insert the pins of the new tube into the sockets and turn the tube about 90° again.
- ✓ Tighten up the screws in the filter holding plate.
- ✓ Reconnect the UV lamp to the power cable and check that it is working properly.

4.2 Cleaning

UV Lamp 4

Use a soft, moist cloth or tissue for cleaning the UV Lamp.

UV Cabinet for UV Lamp 4

Use a soft, moist cloth or tissue for cleaning the UV Cabinet.

Procedure for cleaning the UV filter:

- ✓ Place the UV Cabinet on a table with the viewing window faced down and open the shutter. Pull the releases away from the glass filter (see detail in Figure 3) and remove the UV filter for cleaning.
- ✓ Use a soft cloth or tissue to wipe off the UV filter.

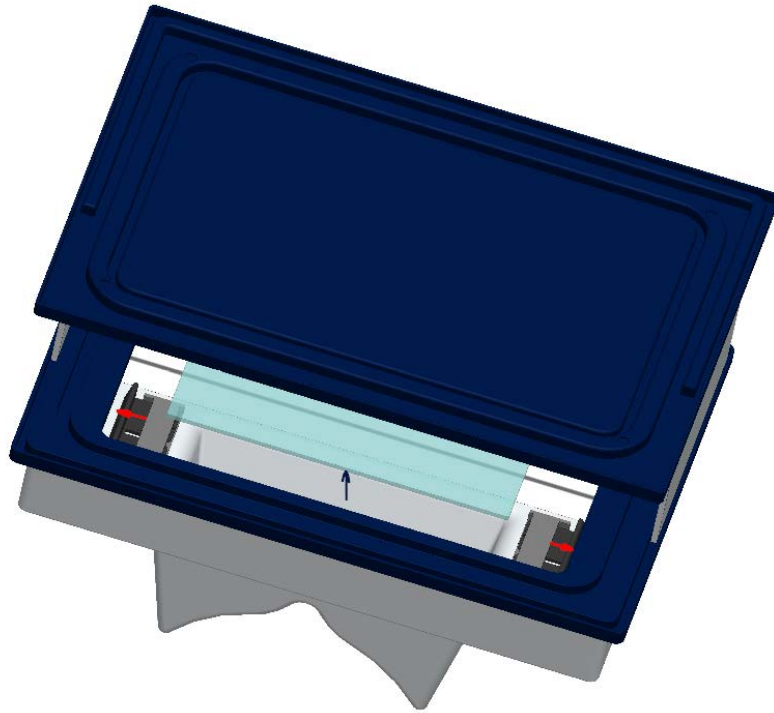

Figure 3





Attention

- *Your eyes are protected from reflected UV light with this filter*
- *Never use the UV Cabinet 4 unless the filter is properly installed!*

5 Technical data

5.1 UV Lamp 4

Dimensions (l x w x h):	412 x 76 x 38 mm		
Weight:	≈ 1.0kg		
Working frequency:	50 kHz – 100 kHz		
Timer:	10 minutes		
Operating temperature:	10 – 40°C		
Operating voltage:	24V 		
Power consumption:	12W		
DC connector polarity:	positive polarity		
Fuse:	1.5AT, 125V		
Mains adapter:	primary:	90-264VAC	47-63Hz
	secondary:	24V 	21.6W
	Safety Class II		
	Short Circuit Protection		
	Over Voltage Protection		

5.2 UV Radiation

The intensity of the UV Lamp 4 is ideally adjusted for the use of TLC / HPTLC plates. Please be aware that direct and reflected UV light can be harmful and has to be avoided.

Average intensities of direct and indirect UV light can be found in Table 5.

For more information, please consult current guidelines such as the *ICNIRP Guidelines on limits of exposure to ultraviolet radiation*. However, CAMAG's intended use of the UV Lamp is only in a protected environment only without any direct radiation to the operator.

Lamp	Measuring point	Intensity $\mu\text{W}/\text{cm}^2$
254 nm, 8W	a	670
	b	100
366 nm, 8W	a	1'400
	b	250

Table 5

Average UV intensities (without using a filter), measured with a radio meter according to Figure 4

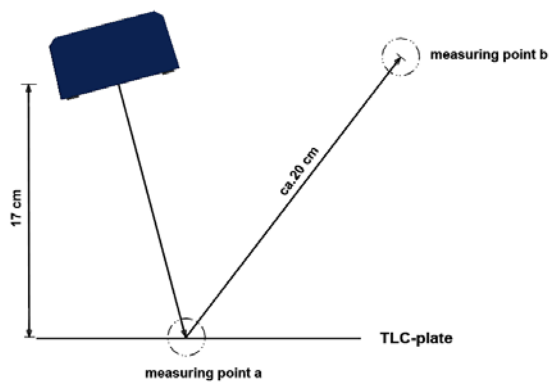

Figure 4

Measuring configuration for Table 5:

Measuring point (a) indicates the intensity on the plate (distance to lamp approx. 17 cm). Measuring point (b) indicate intensities after diffuse reflection on a TLC plate (Silica Gel) measured at a distance of 20 cm. The measurements are performed with a 20 x 20 cm TLC plate without UV indicator. The intensity of the reflection for 20 x 10 cm plates and plates with UV indicator is slightly lower.

5.3 UV Cabinet for UV Lamp 4

Dimensions (l x w x h): 420 x 296 x 280 mm

Weight: \approx 4.0kg

CAMAG (Switzerland) | Sonnenmattstrasse 11 | 4132 Muttenz

Tel. +41 61 467 34 34 | Fax +41 61 461 07 02 | E-Mail: info@camag.com

CAMAG (Germany) | Bismarckstraße 27-29 | 12169 Berlin

Tel. +49 30 516 55 50 | Fax +49 30 795 70 73 | E-Mail: infoberlin@camag.com

CAMAG Scientific Inc. (USA) | 515 Cornelius Harnett Drive | Wilmington, NC 28401

Tel. 800 334 3909 | Fax 910 343 1834 | E-Mail: tlc@camag.com

www.camag.com

EC – Declaration of Conformity

We, CAMAG Chemie-Erzeugnisse und Adsorptionstechnik AG
Sonnenmattstrasse 11
4132 Muttenz
Switzerland

declare under our sole responsibility that the product

CAMAG®

Product name

Article number(s)

to which this declaration relates is in conformity with the following provisions of directive(s):

Following standard(s) or other normative document(s):

Muttenz,

V. Maire-Widmer

Valeria Maire-Widmer, Head Quality Management

SWISS
MADE 

CE